

Very low drop dual voltage regulator

Features

- Output current 1 up to 500 mA
- Output current 2 up to 1.0 A
- Low dropout voltage 1 (0.3 V @ $I_O = 500$ mA)
- Low dropout voltage 2 (0.4 V @ $I_O = 1$ A)
- Very low supply current (typ. 50 μ A in OFF mode, 1.6 mA max in ON mode)
- Logic-controlled electronic shutdown output voltage availability for each regulator: 1.8 V, 2.5 V, 3.3 V
- Internal current and thermal limit
- Stable with low value (min. 4.7 μ F) and low ESR output capacitors
- Supply voltage rejection: 70 dB (typ.)
- Temperature range (- 40 °C to 125 °C)

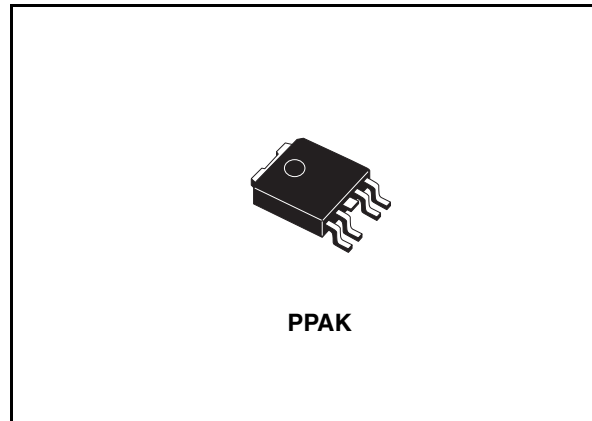

Description

The LDR1833, LDR2533 is a very low drop dual voltage regulator available in PPAK. The very low drop-voltage (0.5 V) and the very low supply current make it particularly suitable for low noise and low power applications such as PDA, Microdrive and other data storage applications while the used high voltage technology makes this device suitable for consumer applications such as Monitors and Set-top-box. For each V_O a shutdown logic control function is available (TTL compatible) to decrease the total power consumption.

Table 1. Device summary

Order codes	Output voltages	
	V_{O1}	V_{O2}
LDR1833PT-R	1.8 V	3.3 V
LDR2533PT-R	2.5 V	3.3 V

Contents

1	Diagram	3
2	Pin configuration	4
3	Maximum ratings	5
4	Typical application	6
5	Electrical characteristics	7
6	Typical characteristics	8
7	Package mechanical data	12
8	Revision history	15

1 Diagram

Figure 1. Block diagram

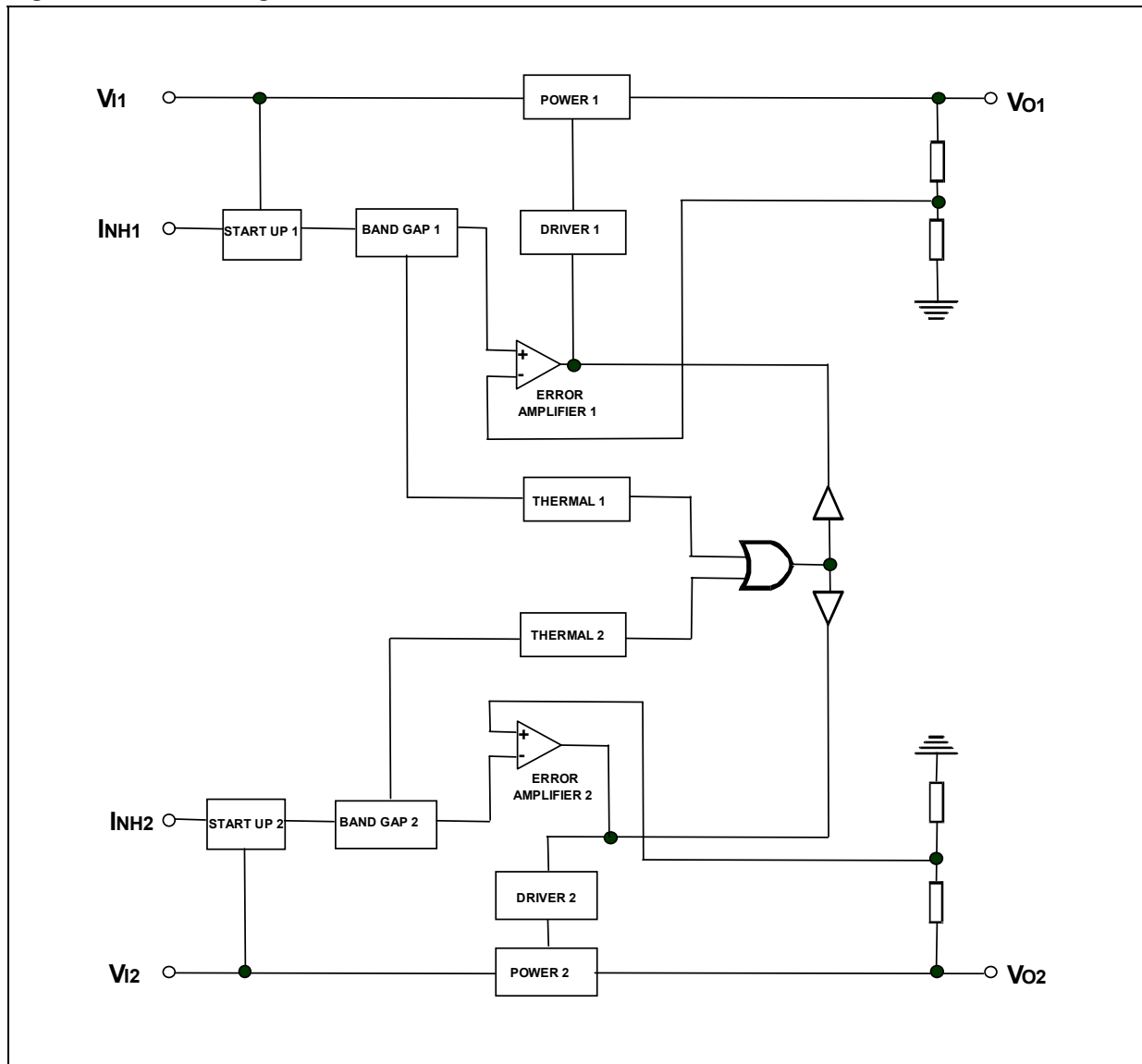

2 Pin configuration

Figure 2. Pin connections (top view)

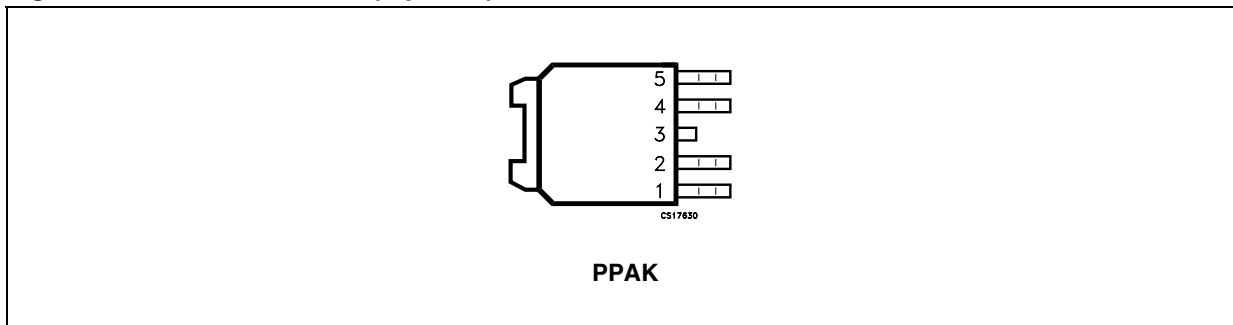

Table 2. Pin description

Pin n°	Symbol	Name and function
3	GND	Ground pin
2	V_{I1}	Input 1 supply pin. Bypass with a 2.2 μ F capacitor to GND
1	V_{I2}	Input 2 supply pin. Bypass with a 2.2 μ F capacitor to GND
4	V_{O1}	Output 1 pin. Bypass with a 4.7 μ F capacitor to GND port
5	V_{O2}	Output 2 pin. Bypass with a 4.7 μ F capacitor to GND port

3 Maximum ratings

Table 3. Absolute maximum ratings

Symbol	Parameter	Value	Unit
V_{I1} & V_{I2}	DC input voltage	-0.3 to 15	V
INH	Shutdown voltage	-0.3 to 15	V
I_O	Output current	Internally limited	
P_D	Power dissipation	Internally limited	
T_{STG}	Storage temperature range	-50 to +150	°C
T_A	Operating ambient temperature range	-40 to +125	°C

Note: Absolute maximum ratings are those values beyond which damage to the device may occur. Functional operation under these condition is not implied.

Table 4. Thermal data

Symbol	Parameter	PPAK	Unit
R_{thJC}	Thermal resistance junction-case	8	°C/W

4 Typical application

Figure 3. Typical application circuit

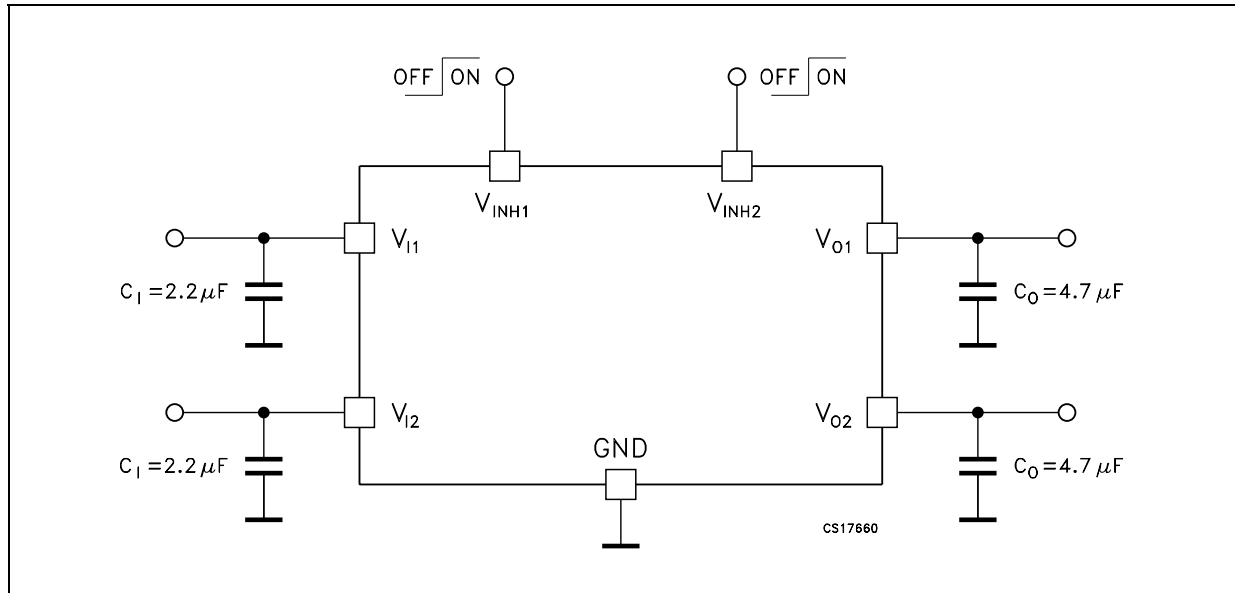

5 Electrical characteristics

Table 5. Electrical characteristics ($V_{I1} = V_{O1} + 2\text{ V}$, $V_{I2} = V_{O2} + 2\text{ V}$, $V_{INH1} = V_{INH2} = 2.5\text{ V}$, $C_{1,2} = 2.2\text{ }\mu\text{F}$, $C_{O1,2} = 4.7\text{ }\mu\text{F}$, $I_{O1} = I_{O2} = 10\text{ mA}$, $T_A = -40\text{ }^\circ\text{C}$ to $125\text{ }^\circ\text{C}$, unless otherwise specified. Typical values are referred at $T_A = 25\text{ }^\circ\text{C}$)

Symbol	Parameter	Test conditions	Min.	Typ.	Max.	Unit
V_{O1}	Output voltage 1		-5	V_{NOM1}	+5	%V
V_{O2}	Output voltage 2		-5	V_{NOM2}	+5	%V
V_{DROP1}	Dropout voltage 1 ⁽¹⁾	$I_{O1} = 500\text{mA}$		0.3	0.7	V
V_{DROP2}	Dropout voltage 2 ⁽¹⁾	$I_{O2} = 1\text{A}$		0.4	0.8	V
ΔV_{O1}	Line regulation 1	$V_{I1} = V_{O1} + 2\text{V}$ to $V_{O1} + 7\text{V}$, $I_O = 250\text{mA}$		15	30	mV
ΔV_{O2}	Line regulation 2	$V_{I2} = V_{O2} + 2\text{V}$ to $V_{O2} + 7\text{V}$, $I_O = 500\text{mA}$		15	40	mV
ΔV_{O1}	Load regulation 1	$V_{I1} = V_{O1} + 2\text{V}$, $I_{O1} = 10$ to 500mA		10		mV
ΔV_{O2}	Load regulation 2	$V_{I2} = V_{O2} + 2\text{V}$, $I_{O2} = 10\text{mA}$ to 1A		60		mV
I_{STOT}	Total supply current	$I_{O1} = I_{O2} = \text{NO LOAD}$		2		mA
I_S	1 channel supply current	NO LOAD		1		mA
I_{QMAX}	Quiescent current	$I_{O1} = 500\text{mA}$, $I_{O2} = 1\text{A}$		30		mA
I_{SC1}	Short circuit current 1	$T_A = 25^\circ$	500	800		mA
I_{SC2}	Short circuit current 2	$T_A = 25^\circ$	1	1.6		A
V_{INH-H}	Enable voltage HIGH		2.4			V
V_{INH-L}	Enable voltage LOW				0.8	V
I_{INH}	Enable pin current	$V_{INH} = 5\text{V}$		6		μA
SVR	Supply voltage rejection ⁽²⁾	$V_{I1,2} = V_{O1,2} + 3\text{V} \pm 1\text{V}$, $I_{O1,2} = 10\text{ mA}$, $f = 120\text{Hz}$		70		dB
e_N	RMS output noise ⁽²⁾	Bandwidth of 10Hz to 100kHz		0.003		% V_O

1. This test is not performed for $V_O < 2.5\text{ V}$.

2. Guaranteed by design, but not tested in production

6 Typical characteristics

(unless otherwise specified $T_J = 25\text{ }^\circ\text{C}$)

Figure 4. Dropout voltage (V_{O1}) vs temperature

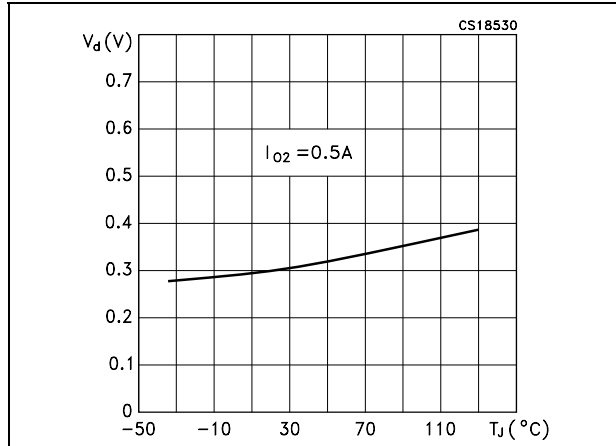

Figure 5. Dropout voltage (V_{O2}) vs temperature

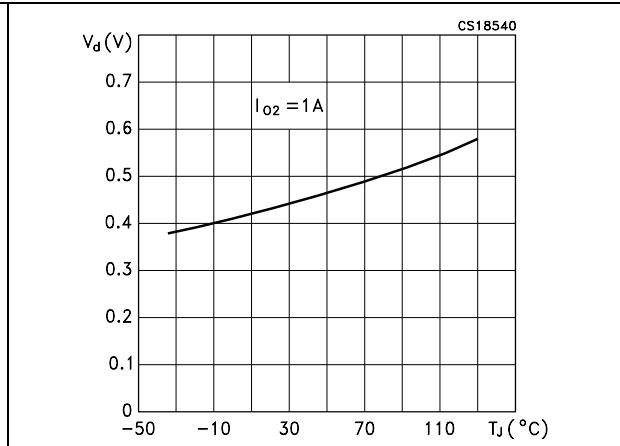

Figure 6. Dropout voltage (V_{O1}) vs temperature

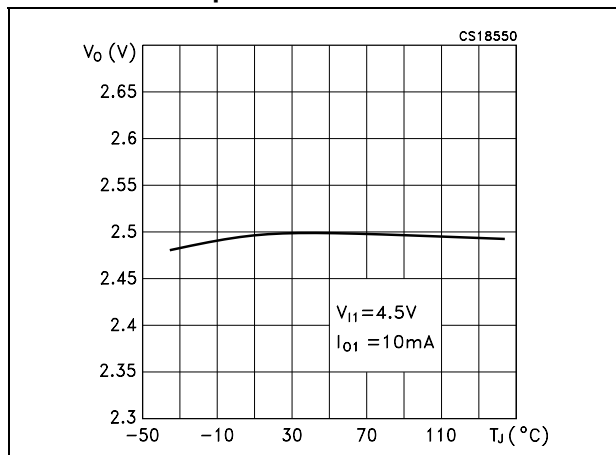

Figure 7. Dropout voltage (V_{O2}) vs temperature

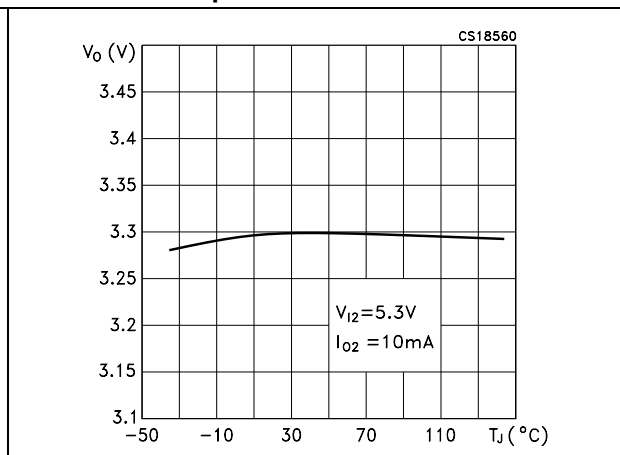

Figure 8. Line regulation (V_{O1}) vs temp.

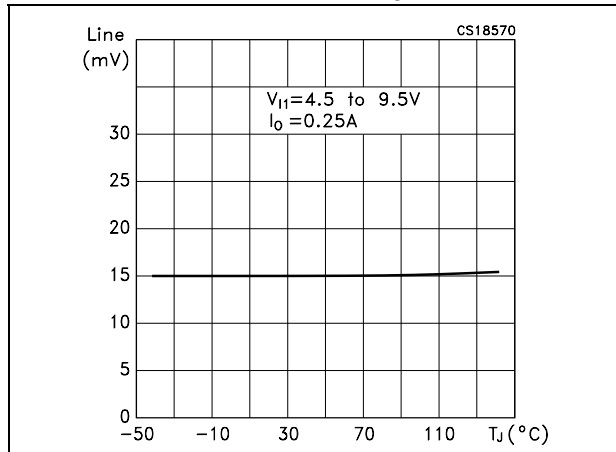

Figure 9. Load regulation (V_{O1}) vs temp.

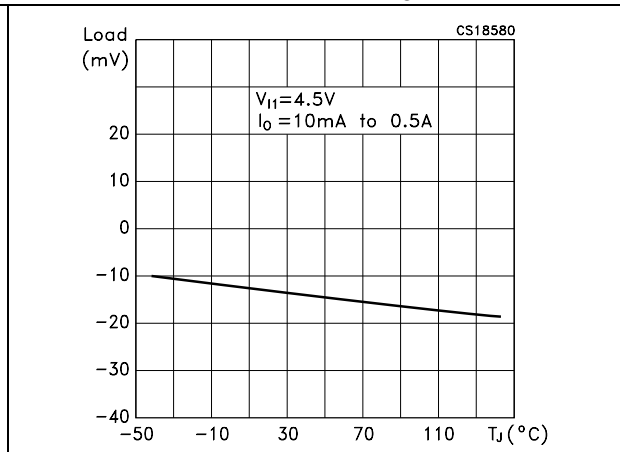

Figure 10. Line regulation (V_{O2}) vs temperature

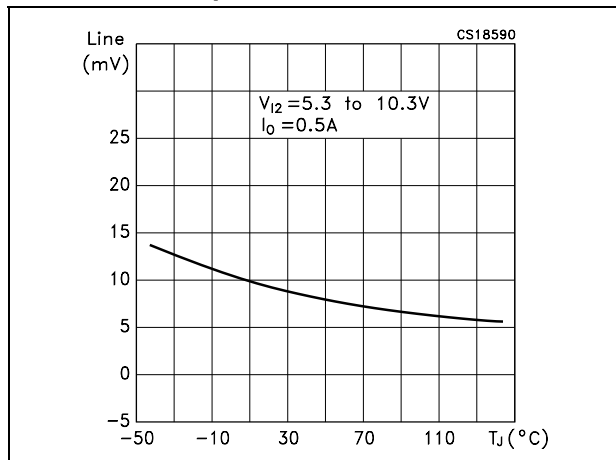

Figure 11. Load regulation (V_{O2}) vs temperature

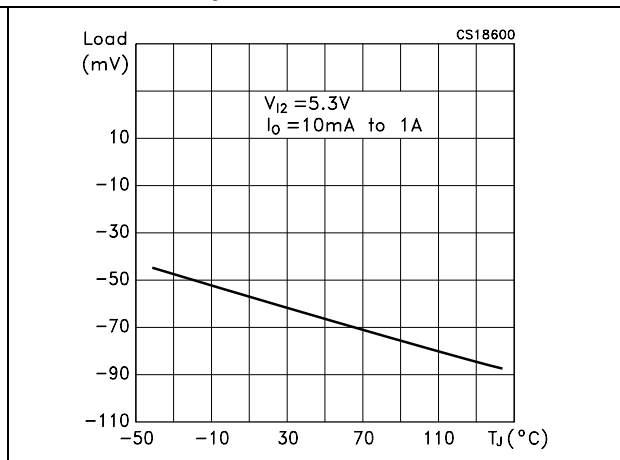

Figure 12. Short circuit current (V_{O1}) vs drop voltage

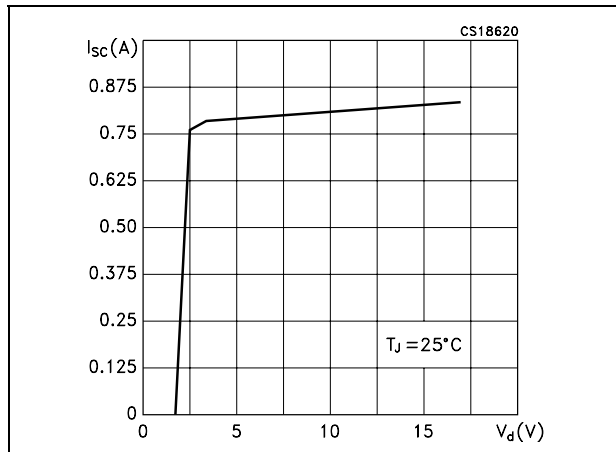

Figure 13. Short circuit current (V_{O2}) vs drop voltage

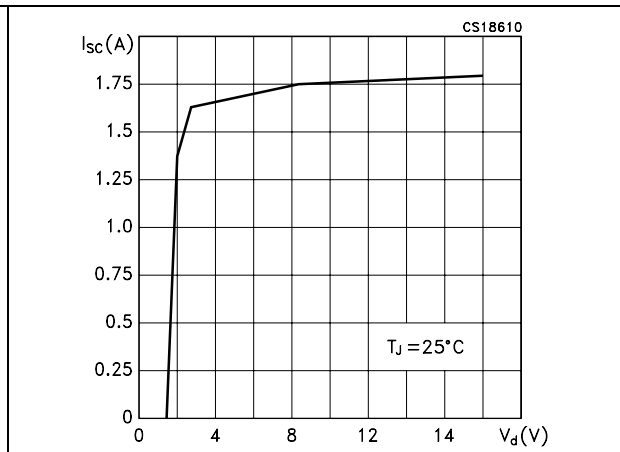

Figure 14. Inhibit voltage vs temperature

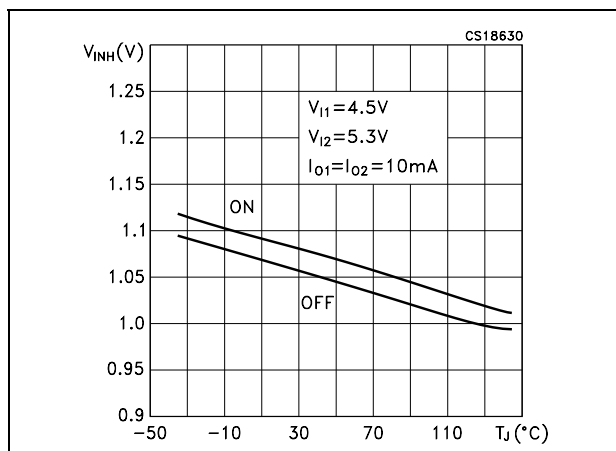

Figure 15. One channel inhibit current vs temperature

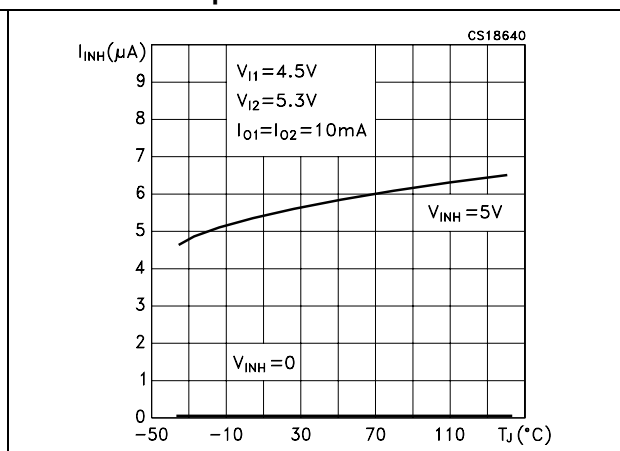

Figure 16. Supply voltage rejection vs (V_{O1}) temperature

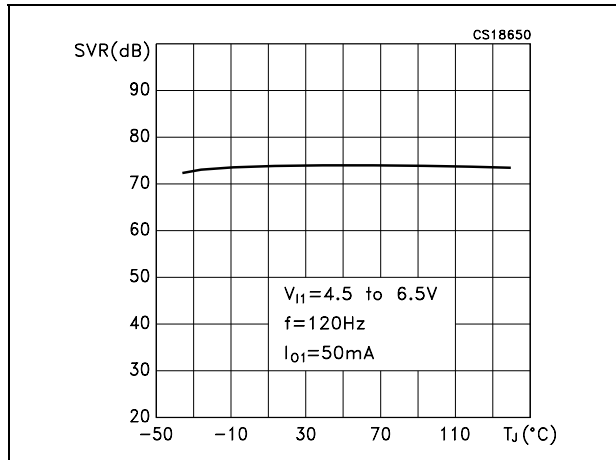

Figure 17. Supply voltage rejection vs (V_{O2}) temperature

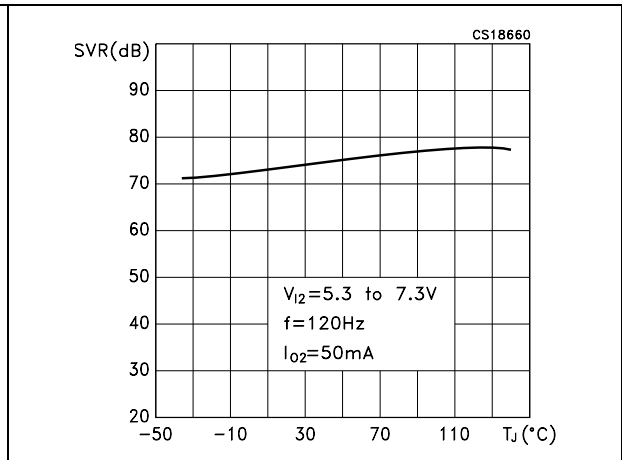

Figure 18. Supply voltage rejection (V_{O1}) vs frequency

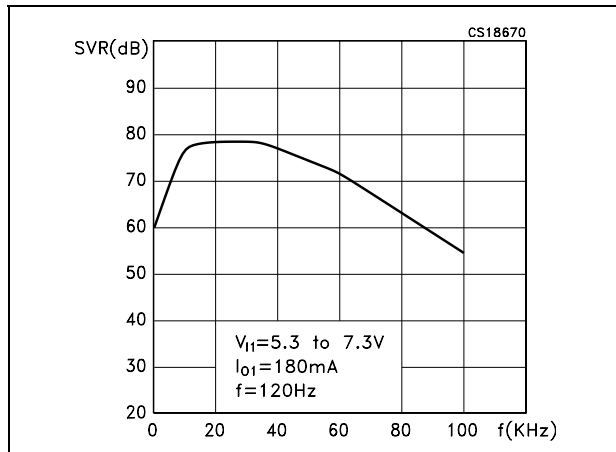

Figure 19. Supply voltage rejection (V_{O2}) vs frequency

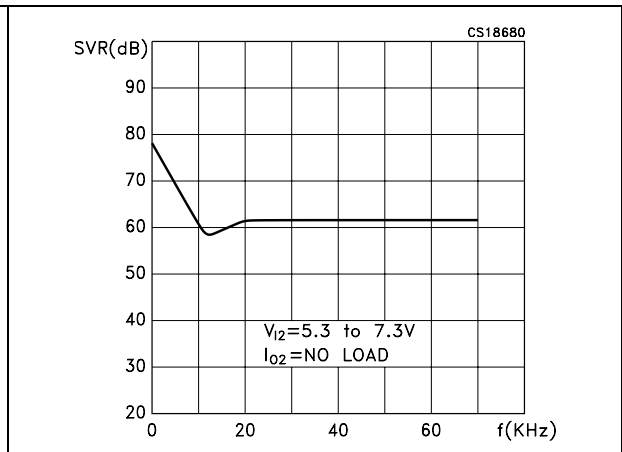

Figure 20. Maximum total quiescent current vs temperature

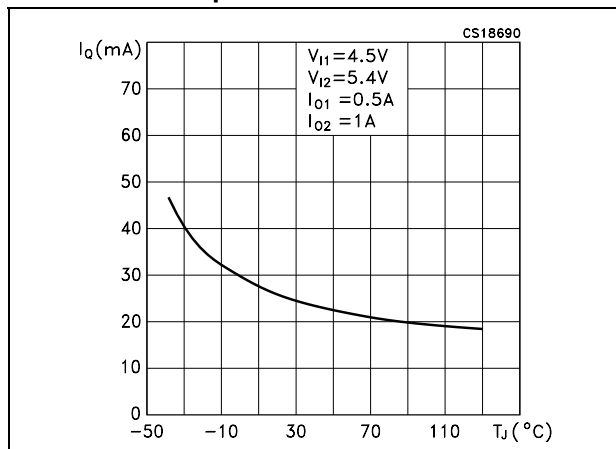

Figure 21. Total supply current vs temperature

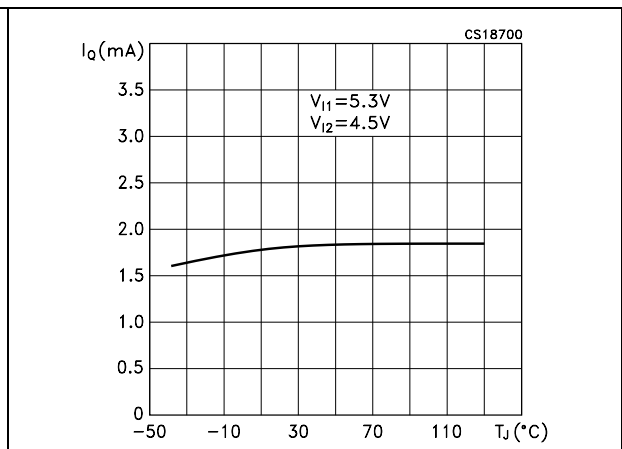

Figure 22. Quiescent current (V_{O1}) vs output current

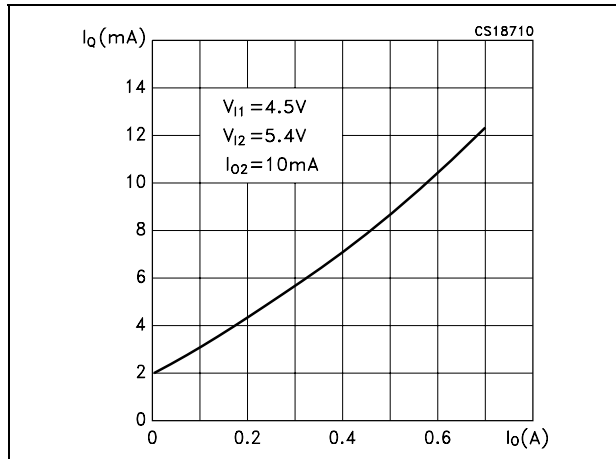

Figure 23. Quiescent current (V_{O2}) vs output current

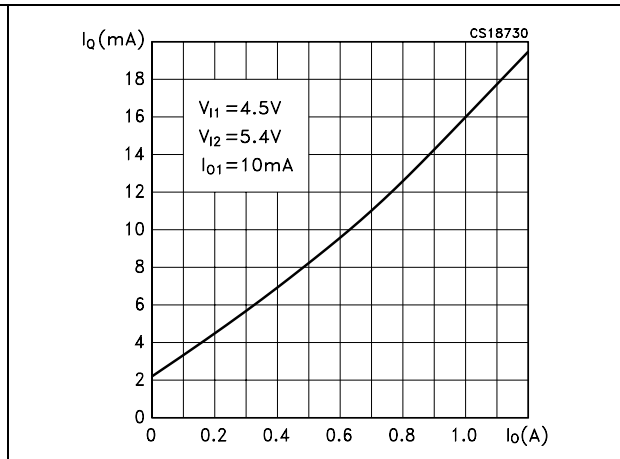

Figure 24. Thermal protection vs V_{O1}

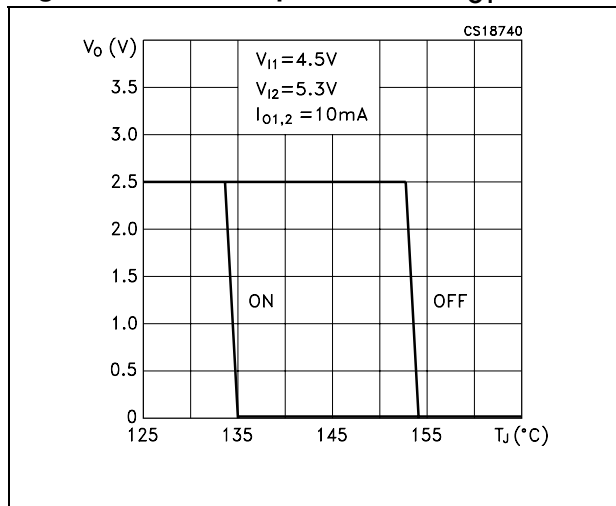

Figure 25. Load transient

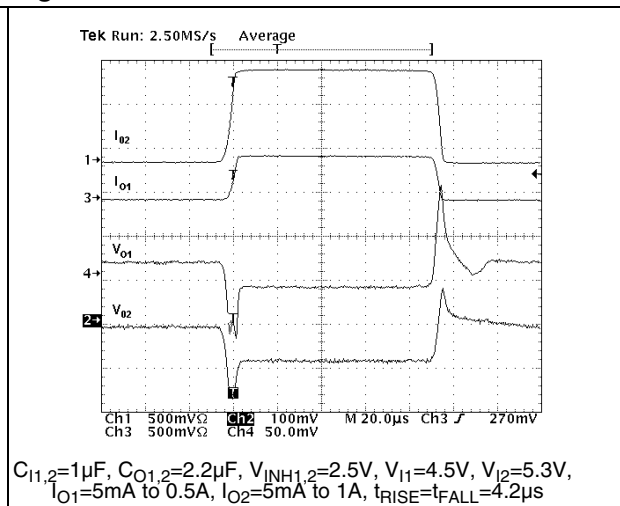

Figure 26. Line transient $V_{O1,2}$

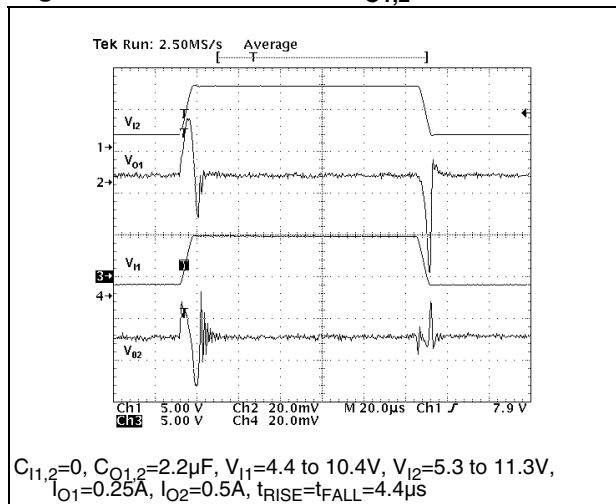
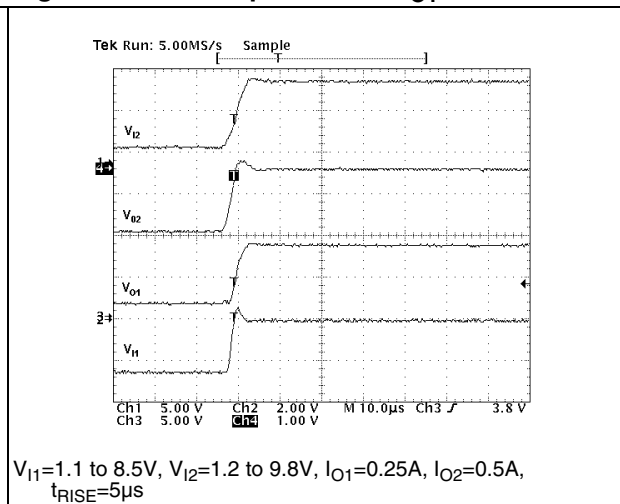

Figure 27. Start up transient V_{O1}



7 Package mechanical data

In order to meet environmental requirements, ST offers these devices in ECOPACK® packages. These packages have a lead-free second level interconnect. The category of second Level Interconnect is marked on the package and on the inner box label, in compliance with JEDEC Standard JESD97. The maximum ratings related to soldering conditions are also marked on the inner box label. ECOPACK is an ST trademark. ECOPACK specifications are available at: www.st.com.

PPAK mechanical data

Dim.	mm.			inch.		
	Min.	Typ.	Max.	Min.	Typ.	Max.
A	2.2		2.4	0.086		0.094
A1	0.9		1.1	0.035		0.043
A2	0.03		0.23	0.001		0.009
B	0.4		0.6	0.015		0.023
B2	5.2		5.4	0.204		0.212
C	0.45		0.6	0.017		0.023
C2	0.48		0.6	0.019		0.023
D	6		6.2	0.236		0.244
D1		5.1			0.201	
E	6.4		6.6	0.252		0.260
E1		4.7			0.185	
e		1.27			0.050	
G	4.9		5.25	0.193		0.206
G1	2.38		2.7	0.093		0.106
H	9.35		10.1	0.368		0.397
L2		0.8	1		0.031	0.039
L4	0.6		1	0.023		0.039
L5	1			0.039		
L6		2.8			0.110	

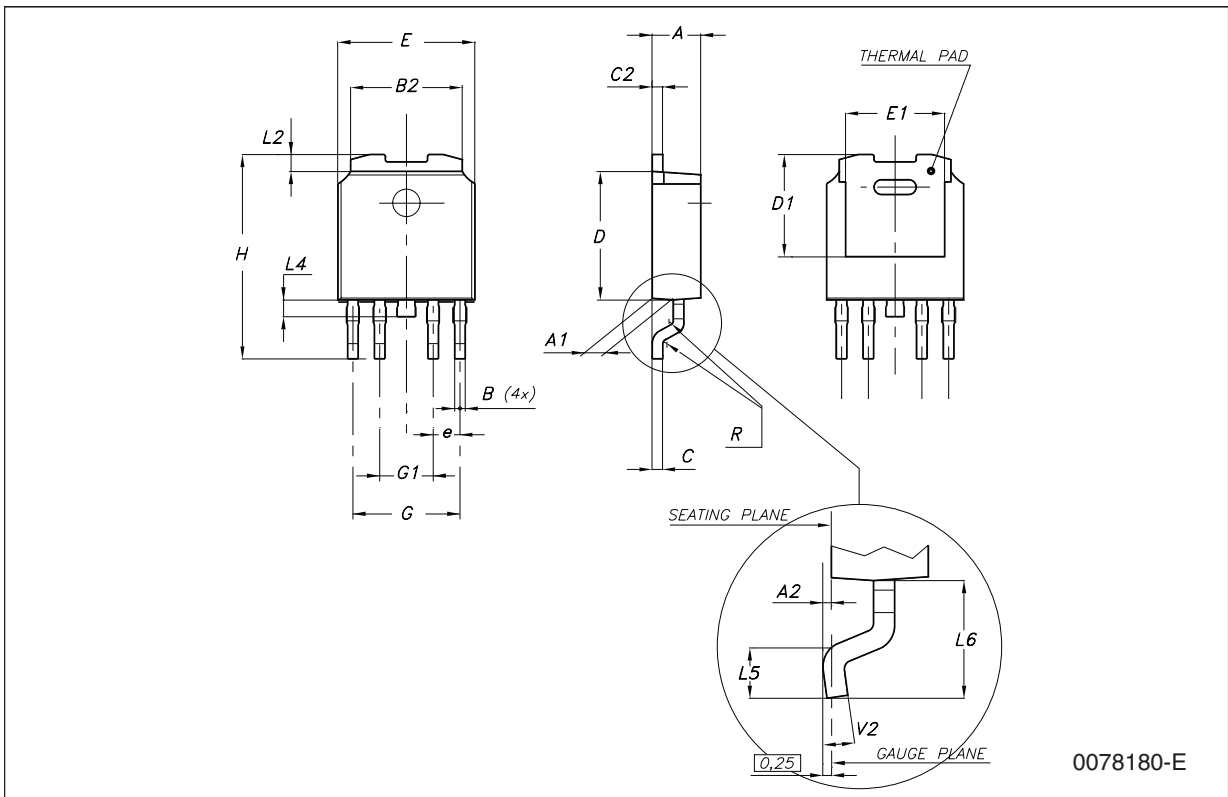

0078180-E

Tape & reel DPAK-PPAK mechanical data

Dim.	mm.			inch.		
	Min.	Typ.	Max.	Min.	Typ.	Max.
A			330			12.992
C	12.8	13.0	13.2	0.504	0.512	0.519
D	20.2			0.795		
N	60			2.362		
T			22.4			0.882
Ao	6.80	6.90	7.00	0.268	0.272	0.276
Bo	10.40	10.50	10.60	0.409	0.413	0.417
Ko	2.55	2.65	2.75	0.100	0.104	0.105
Po	3.9	4.0	4.1	0.153	0.157	0.161
P	7.9	8.0	8.1	0.311	0.315	0.319

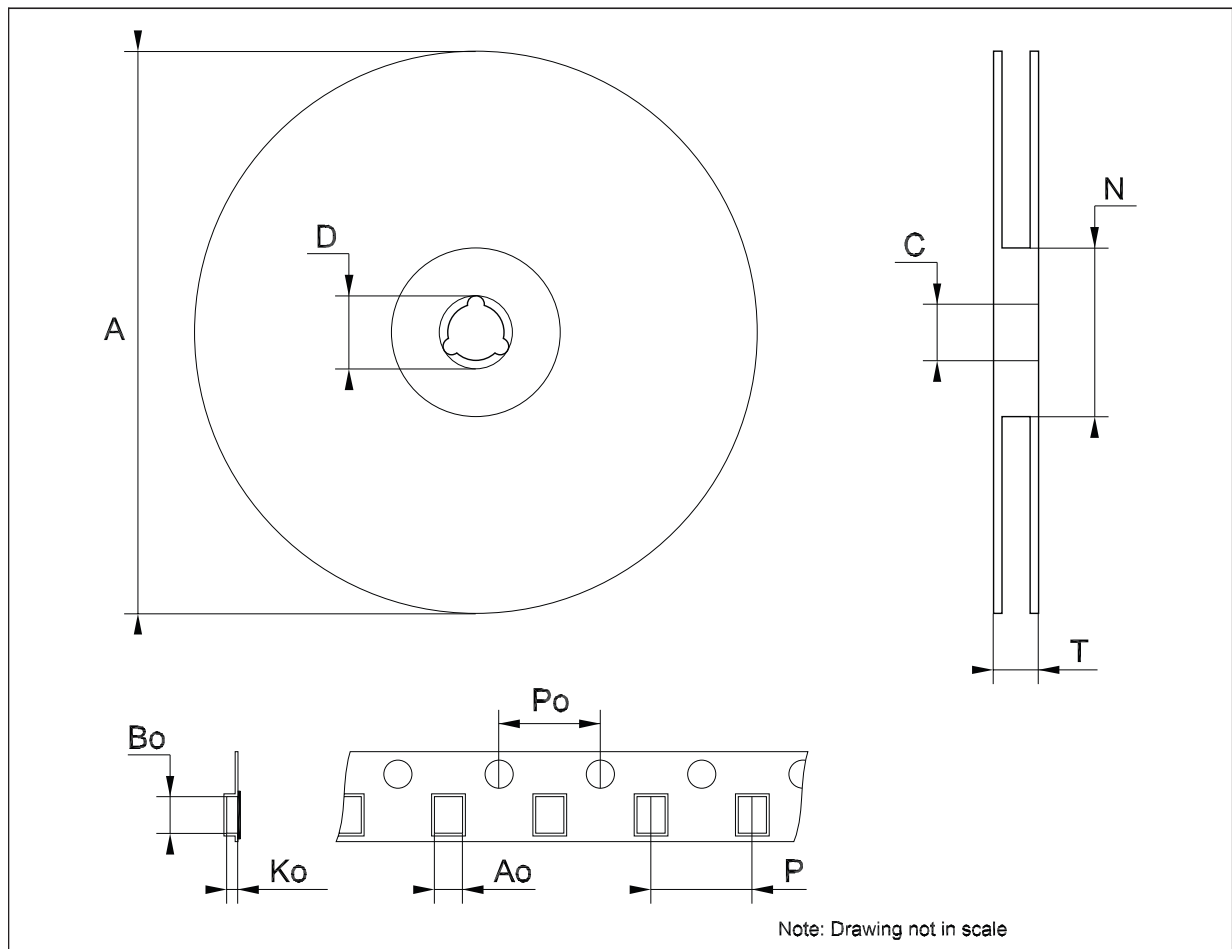

8 Revision history

Table 6. Document revision history

Date	Revision	Changes
03-Aug-2004	2	Modified: tables 1, 3, 5 and figures 3, 6, 10, 11, 14, 17, 22, 23.
15-Apr-2008	3	Modified: Table 1 on page 1 .

Please Read Carefully:

Information in this document is provided solely in connection with ST products. STMicroelectronics NV and its subsidiaries ("ST") reserve the right to make changes, corrections, modifications or improvements, to this document, and the products and services described herein at any time, without notice.

All ST products are sold pursuant to ST's terms and conditions of sale.

Purchasers are solely responsible for the choice, selection and use of the ST products and services described herein, and ST assumes no liability whatsoever relating to the choice, selection or use of the ST products and services described herein.

No license, express or implied, by estoppel or otherwise, to any intellectual property rights is granted under this document. If any part of this document refers to any third party products or services it shall not be deemed a license grant by ST for the use of such third party products or services, or any intellectual property contained therein or considered as a warranty covering the use in any manner whatsoever of such third party products or services or any intellectual property contained therein.

UNLESS OTHERWISE SET FORTH IN ST'S TERMS AND CONDITIONS OF SALE ST DISCLAIMS ANY EXPRESS OR IMPLIED WARRANTY WITH RESPECT TO THE USE AND/OR SALE OF ST PRODUCTS INCLUDING WITHOUT LIMITATION IMPLIED WARRANTIES OF MERCHANTABILITY, FITNESS FOR A PARTICULAR PURPOSE (AND THEIR EQUIVALENTS UNDER THE LAWS OF ANY JURISDICTION), OR INFRINGEMENT OF ANY PATENT, COPYRIGHT OR OTHER INTELLECTUAL PROPERTY RIGHT.

UNLESS EXPRESSLY APPROVED IN WRITING BY AN AUTHORIZED ST REPRESENTATIVE, ST PRODUCTS ARE NOT RECOMMENDED, AUTHORIZED OR WARRANTED FOR USE IN MILITARY, AIR CRAFT, SPACE, LIFE SAVING, OR LIFE SUSTAINING APPLICATIONS, NOR IN PRODUCTS OR SYSTEMS WHERE FAILURE OR MALFUNCTION MAY RESULT IN PERSONAL INJURY, DEATH, OR SEVERE PROPERTY OR ENVIRONMENTAL DAMAGE. ST PRODUCTS WHICH ARE NOT SPECIFIED AS "AUTOMOTIVE GRADE" MAY ONLY BE USED IN AUTOMOTIVE APPLICATIONS AT USER'S OWN RISK.

Resale of ST products with provisions different from the statements and/or technical features set forth in this document shall immediately void any warranty granted by ST for the ST product or service described herein and shall not create or extend in any manner whatsoever, any liability of ST.

ST and the ST logo are trademarks or registered trademarks of ST in various countries.

Information in this document supersedes and replaces all information previously supplied.

The ST logo is a registered trademark of STMicroelectronics. All other names are the property of their respective owners.

© 2008 STMicroelectronics - All rights reserved

STMicroelectronics group of companies

Australia - Belgium - Brazil - Canada - China - Czech Republic - Finland - France - Germany - Hong Kong - India - Israel - Italy - Japan - Malaysia - Malta - Morocco - Singapore - Spain - Sweden - Switzerland - United Kingdom - United States of America

www.st.com